

1E377390 | JUPITER PRO

Professional adjustable LED projector

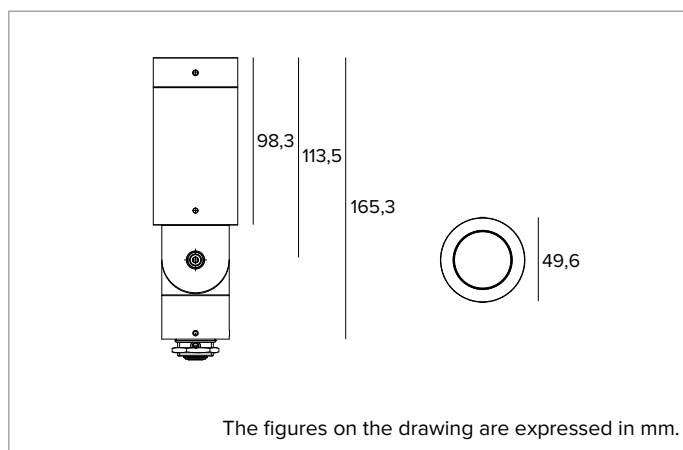

	2700K	H(m)	D(m)	E _{max} (lx)		
	Ra90		8°			
	Fixture Power	8W	1	0.15	11580	
	Source Flux	479lm	2	0.30	2895	
	Fixture Flux	362lm	3	0.44	1287	
	Efficacy	47lm/W	4	0.59	724	
TS1404	I _{max} =24196cd/klm	I _{max}	11580cd	5	0.74	463



SOURCE

Emitter Ra90.

Energy efficiency class: G

Nominal power: 5,7W

Nominal flux: 479lm

Colour rendering index: 90

Rf: 94

Rg: 99

CCT nominal: 2700K

Lifetime (L80/B10): >50000h tq +25°C

ILLUMINOTECHNICAL CHARACTERISTICS

NSP version: PMMA lens and fixed holographic filter.

Optic: LENS

Beam angles: NSP

Optical efficiency: 76%

Fixture flux: 362lm

Luminous efficacy: 46lm/W

Photobiological safety: Compliant with RG1 low risk group

MECHANICAL CHARACTERISTICS

Frame and joint in aluminium with CNC machining, anodised and painted. ±360° rotation on the horizontal plane and 180° on the vertical plane.

Colour and finish: Ferrite

Dimensions: Ø50

Weight: 0.62Kg

Version: FIXED

Degree of protection: IP66

Mechanical Resistance: IK08

ELECTRICAL CHARACTERISTICS

24V resin driver card built into the product. Pre-wired with 3m of 2-pole 18AWG cable with built-in acquastop device.

Fixture Power: 8W

Power supply: 24Vdc

Insulation Class: CLASS 3

Driver included: NO

Class F: YES

Ambient temperature: -25°C / +35°C

INSTALLATION

Joint at the base of the product equipped with hexagonal socket screw for positioning. The product may be installed using our accessories: plate for mounting on surfaces or spike for in-ground installation. It is also possible to install the product with any other support with a G ½ shank hole.

NOTES

Dimmable with a special accessory kit. Casambi control system available using a dedicated accessory (only with DALI dimmer). Uses the "Waterblock Smart" technical solution that involves resin coating the connection cables, limiting the risk of humidity reaching the driver or the fixture. 110-277Vac version available on request. Commissioning of the control system via free APP; the intervention of a specialist technician can be quoted on request.

WARRANTY

5 years.

WARNING

Luminaire designed for disposal/recycling at end-of-life. Replaceable (LED only) light source by a professional.

Due to the technological evolution of the electronic components, the data provided may be updated, and as such, confirmation must be requested during the order process.

Luminous flux and power supply have +/-10% tolerances with respect to the indicated value. tq +25°C (CIE 121).

We reserve the right to make technical changes.

Targetti Sankey S.r.l.
Via Pratese, 164
50145 Firenze - Italy
Tel: +39 055 37911
targetti.com
targetti@targetti.com

CCIAA Firenze
Share Capital:
€ 500.000,00
VAT N. (IT):
01537660480
R.E.A: FI-275656

TARGETTI

1E377390 | JUPITER PRO

Professional adjustable LED projector

Related codes

Mounting System



Ø mm	H mm	Colour	Code
50	232		1E3785
50	232		1E3785BT

Earthspike.
Powder coated stainless steel.



Colour	Code
	1E3786

Plate for fixture rotation (surface installation).
Powder coated stainless steel.

Power Supply



Dimensions LxHxP mm	Power	Power supply	Output voltage	IP	Code
122x26x54	17W	220-240Vac	24Vdc	IP68	1E4397EL

Electronic ON-OFF power supply.

Dimensions LxHxP mm	Power	Power supply	Output voltage	IP	Code
185x22x64	50W	220-240Vac	24Vdc	IP20	1T3726
140x32x63	75W	220-240Vac	24Vdc	IP67	1T3586
230x87x43	100W	220-240Vac	24Vdc	IP67	1T3587
238x42x67	200W	220-240Vac	24Vdc	IP67	1T3588

Electronic ON-OFF power supply.

Accessories

Filter



Code
1E3790

Blade of light filter.
PMMA holographic filter for a blade of light effect.
Diameter 36mm.

Grid



Code
1E3792

Anti-glare louver.
Black painted metal honeycomb structure.
Ready to be housed inside the optical compartment.
Diameter 36mm.

Screen



Colour	Code
	1E3788

Asymmetric screen.
Powder coated stainless steel.
Diameter 36mm.

Due to the technological evolution of the electronic components, the data provided may be updated, and as such, confirmation must be requested during the order process.
Luminous flux and power supply have +/-10% tolerances with respect to the indicated value. tq +25°C (CIE 121).

We reserve the right to make technical changes.

Targetti Sankey S.r.l.
Via Pratese, 164
50145 Firenze - Italy
Tel: +39 055 37911
targetti.com
targetti@targetti.com

CCIAA Firenze
Share Capital:
€ 500.000,00
VAT N. (IT):
01537660480
R.E.A: FI-275656



1E377390 | JUPITER PRO

Professional adjustable LED projector

Connector



Code

1E2769

Linear connection box IP66/IP68.
5 poles max. wire section 1.5mm².
Cable diameter range from 7 to 12mm.



Code

1E2494

Multiple connection box IP68.
1 IN - 3 OUT 4 poles max. wire section 2.5mm².
Cable diameter range from 6 to 12mm.

Tool



Code

1E3305

Tightening wrench for the connector kit.

Control systems

Code

1T6581

Dimmer for 12-24Vdc constant voltage LED driver.
1-10V/DALI control input.
IP20



Code

1E3048

IP67 wireless control unit with DALI interface.
It generates a local DALI2 bus, enabling a direct connection to a DALI interface LED driver.
The module can only be used in a closed system and cannot be connected to an existing DALI network.
The module is wireless controlled using a Casambi app for smartphones and tablets using Bluetooth 5.0 technology.
The devices automatically create an adaptive, robust, and reliable wireless mesh network, allowing for the easy and efficient management of a high number of fixtures. The control unit is preset to the DALI 1CH profile, meaning the device can control a single DALI driver with broadcast commands.
In addition to the DALI broadcast, other operating modes are available, such as:

- Button (normally open)
- Control unit 0/1-10V
- Control unit DALI Tunable White DT8
- Presence sensor

Due to the technological evolution of the electronic components, the data provided may be updated, and as such, confirmation must be requested during the order process.

Luminous flux and power supply have +/-10% tolerances with respect to the indicated value. tq +25°C (CIE 121).

We reserve the right to make technical changes.

Targetti Sankey S.r.l.
Via Pratese, 164
50145 Firenze - Italy
Tel: +39 055 37911
targetti.com
targetti@targetti.com

CCIAA Firenze
Share Capital:
€ 500.000,00
VAT N. (IT):
01537660480
R.E.A: FI-275656

TARGETTI

1E377390 | JUPITER PRO

Professional adjustable LED projector

Control systems



Code

1E4369

IP67 Extender for wireless control of LED driver with dimming DALI interface based on Casambi technology.

It has a DALI2 output with the capacity to control up to 40 lighting fixtures.

With the addition of a further external BUS DALI power supply it is possible to control up to 64 fixtures.

IP67 Extender is preset to the DALI broadcast profile, meaning all the luminaires connected to it are dimmable at the same level.

In addition to the DALI broadcast other operating modes are available, such as:

- EXTENDER DALI 8CH
- EXTENDER DALI Tunable White
- EXTENDER DALI 4CH
- EXTENDER DALI DT8 Tunable White

Due to the technological evolution of the electronic components, the data provided may be updated, and as such, confirmation must be requested during the order process.

Luminous flux and power supply have +/-10% tolerances with respect to the indicated value. tq +25°C (CIE 121).

We reserve the right to make technical changes.

Targetti Sankey S.r.l.
Via Pratese, 164
50145 Firenze - Italy
Tel: +39 055 37911
targetti.com
targetti@targetti.com

CCIAA Firenze
Share Capital:
€ 500.000,00
VAT N. (IT):
01537660480
R.E.A.: FI-275656

TARGETTI